

S-203

Vinyl Track
for S-125 3/8" Screen Frame
(White PVC - 12 ft Lengths)

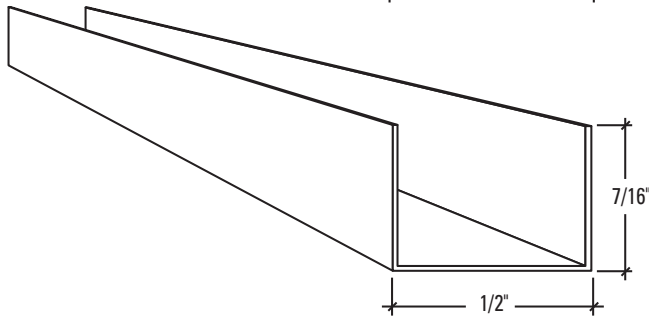

S-205

Vinyl Track
for S-126 7/16" Screen Frame
(White PVC - 12 ft Lengths)

S-422

Toggle Spring Bolt Assembly
with Barrel

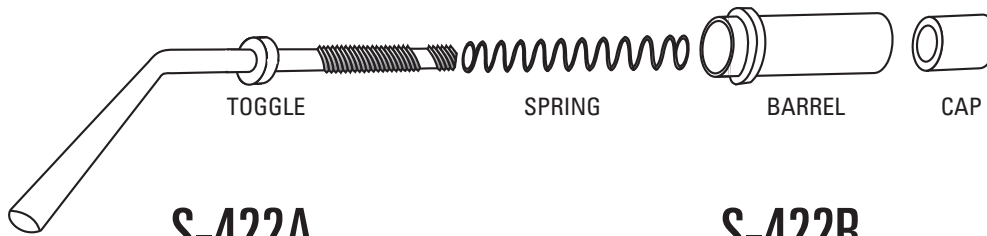

S-422A

Toggle Spring Bolt without Barrel

S-422B

Barrel Only

S-423/424

Lance Latches (Sold separately, bulk)
Available Finishes:
Mill or White Aluminum

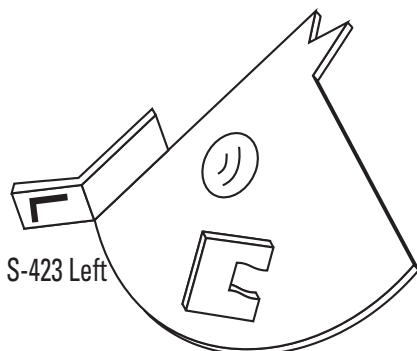

S-423 Left

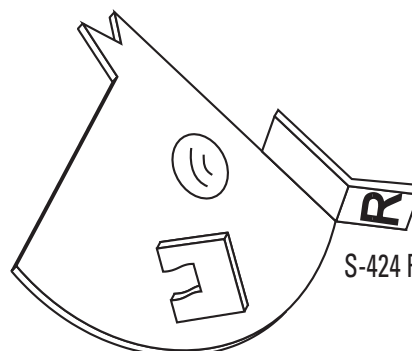

S-424 Right



S-426

Retainer Clip
Stainless Steel

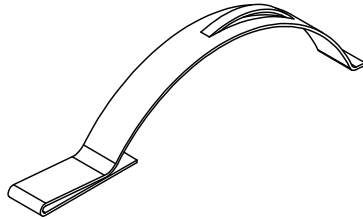

S-427

Corner Compression Spring with Retainer
Stainless Steel

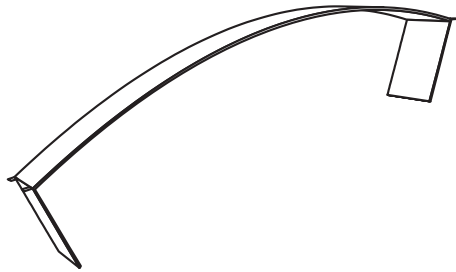

S-428

Compression Spring
Stainless Steel
3/16" Dia. Holes Required

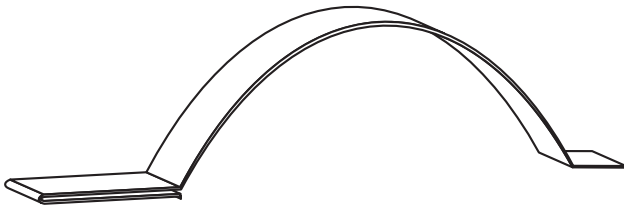

S-429

Corner Compression Spring
Stainless Steel

S-429-AD

Corner Compression Spring
Stainless Steel - Heavy Duty

S-430, S-430A, S-431

Interior Plastic Retainer Clip

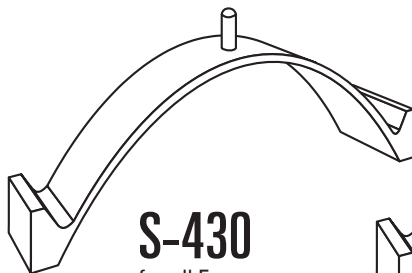

S-430

for all Frames
except 5/16"
Round Tip

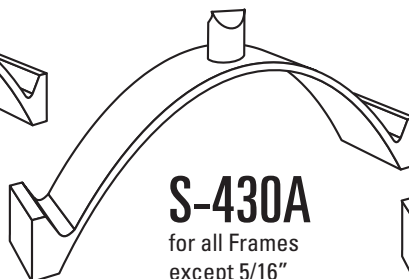

S-430A

for all Frames
except 5/16"
Chisel Head

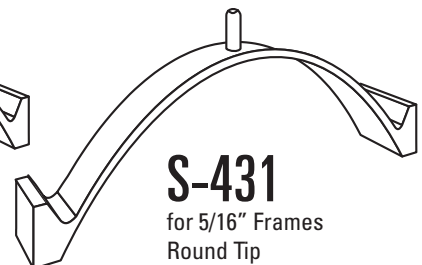

S-431

for 5/16" Frames
Round Tip

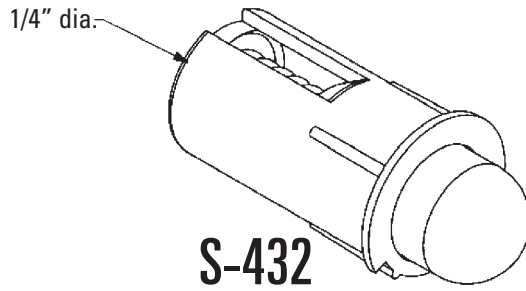

S-432
Plastic Bullet Catch

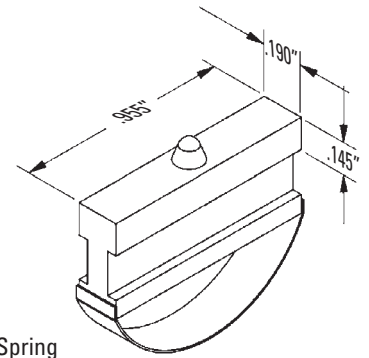

S-433
Retainer Clip with Spring
for S-132 Extruded Screen Frame

5/16" Turn Clip



S-458
Zinc Plated
#8 x 3/4" and #2 Socket - Type A STS

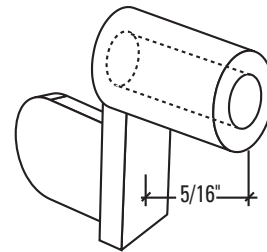

S-436-M
Zinc Diecast
S-436-P
Plastic

1" Turn Clip



S-456
Zinc Plated
#8 x 1-1/2" and #2 Socket - Type A STS

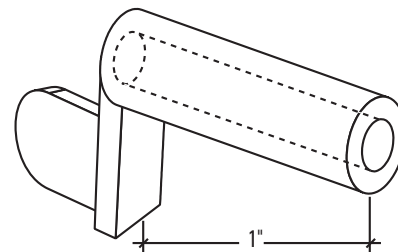

S-440-M
Zinc Diecast
S-440-P
Plastic

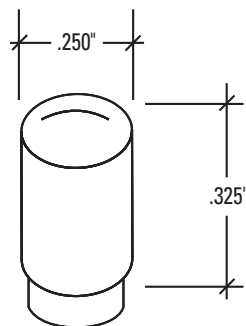

S-450
Fixed Pin

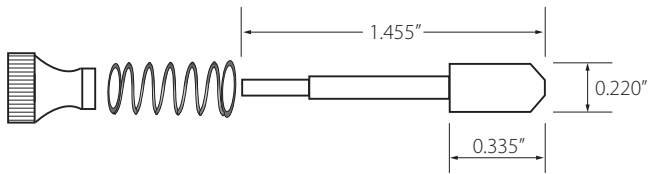

S-481-M

1/4" Dia. Spring Bolt Assembly
with Metal Head, Metal Shaft
Sold in bulk, unassembled

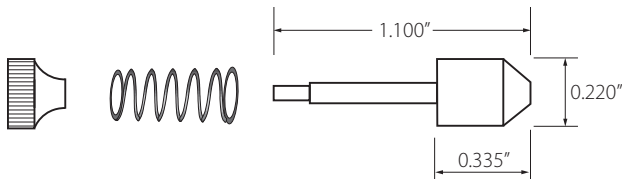

S-481-MS

1/4" Dia. Spring Bolt Assembly
with Metal Head, Metal Shaft
Sold in bulk, unassembled

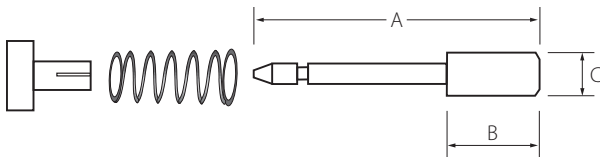

S-485-P, S-485-PS

3/16" Dia. Spring Bolt Assembly
with Nylon Snap-on Head, Metal Shaft
White / Black Head Available
Sold in bulk, unassembled

Part Number	Dimensions (in)		
	A	B	C
S-485-P	1.375	0.400	0.185
S-485-PS	1.140	0.265	0.185

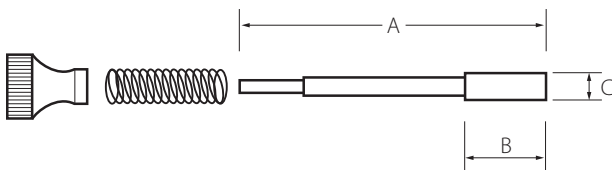

S-486M, S-486ML

1/8" Dia. Spring Bolt Assembly
with Metal Head, Metal Shaft
Sold in bulk, unassembled

Part Number	Dimensions (in)		
	A	B	C
S-486-M	1.400	0.400	0.125
S-486-ML	1.455	0.465	0.125

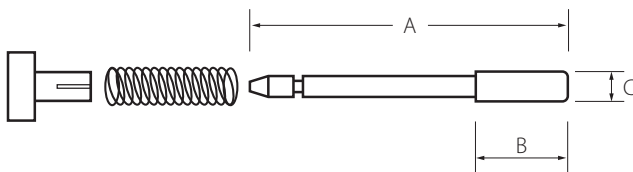

S-486-P, S-486-PL

1/8" Dia. Spring Bolt Assembly
with Nylon Snap-on Head, Metal Shaft
White / Black Head Available
Sold in bulk, unassembled

Part Number	Dimensions (in)		
	A	B	C
S-486-P	1.365	.395	.125
S-486-PL	1.465	.395	.125

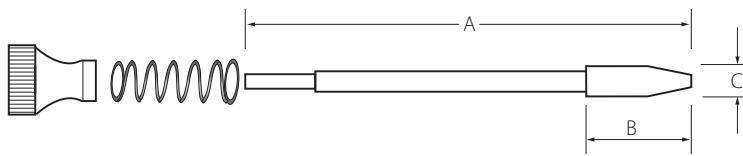

S-486-MLT, S-486-ML135

Spring Bolt - Assembly with Metal Head,
Metal Shaft, and Tapered Tip

Part Number	Dimensions (in)		
	A	B	C
S-486-MLT	1.460	0.455	0.125
S-486-MLT-135	1.460	0.365	0.135

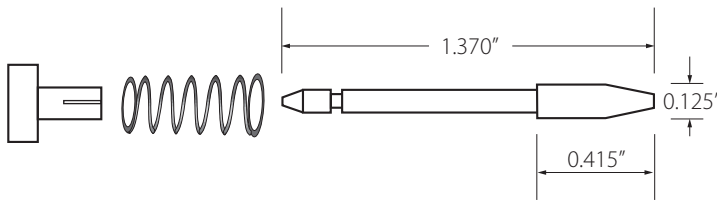

S-486-PP

Regular Length 1/8" Dia. Spring
Bolt Assembly with Tapered Tip,
Nylon Snap-on Head,
Metal Shaft
White / Black Head Available

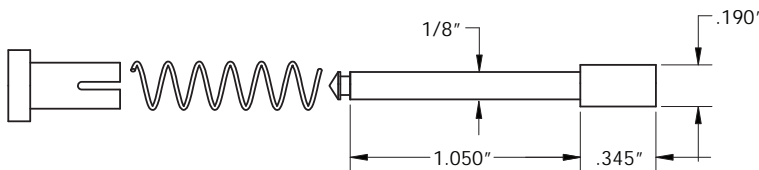

S-487-P

3/16" Dia. Spring Bolt
Plastic Shaft and Head

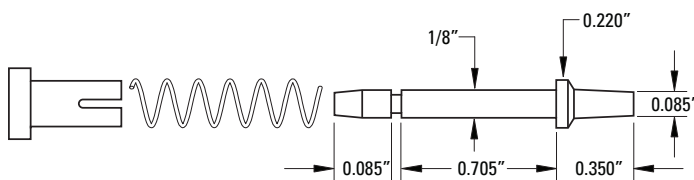

S-487-P-B

#138
1/8" Dia. Spring Bolt Assembly
With Tapered Tip
Nylon Shaft and Head

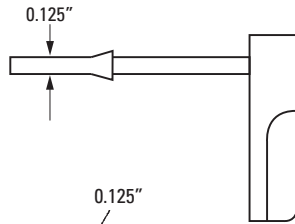

S-488
Push Pins
White Nylon

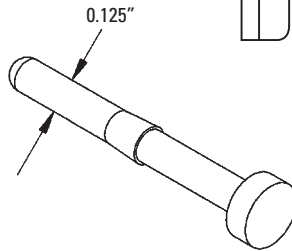

S-489
Mark x Pin
White Nylon

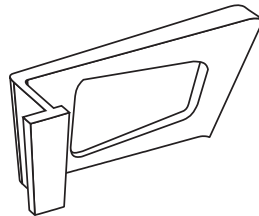

S-500
Screen Pull Handle, Plastic
Black, White or Clear

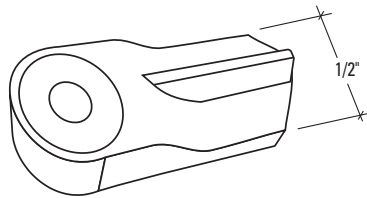

S-501
Flush Turn Clip
White Nylon

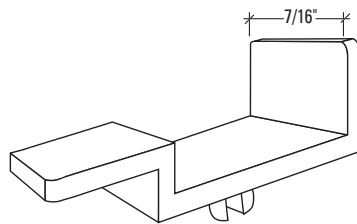

S-502
Press-On U-Clip, Plastic
White

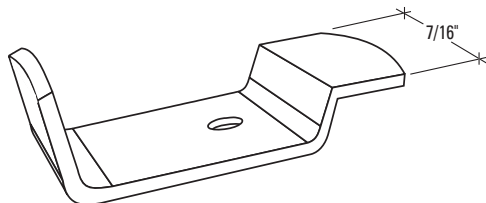

S-503
U-Clip
Aluminum Mill Finish

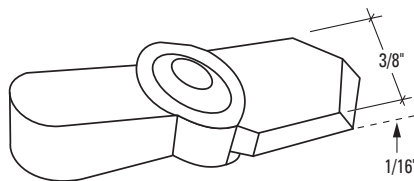

S-504
Turn Clip - 1/16" Step
White Nylon